

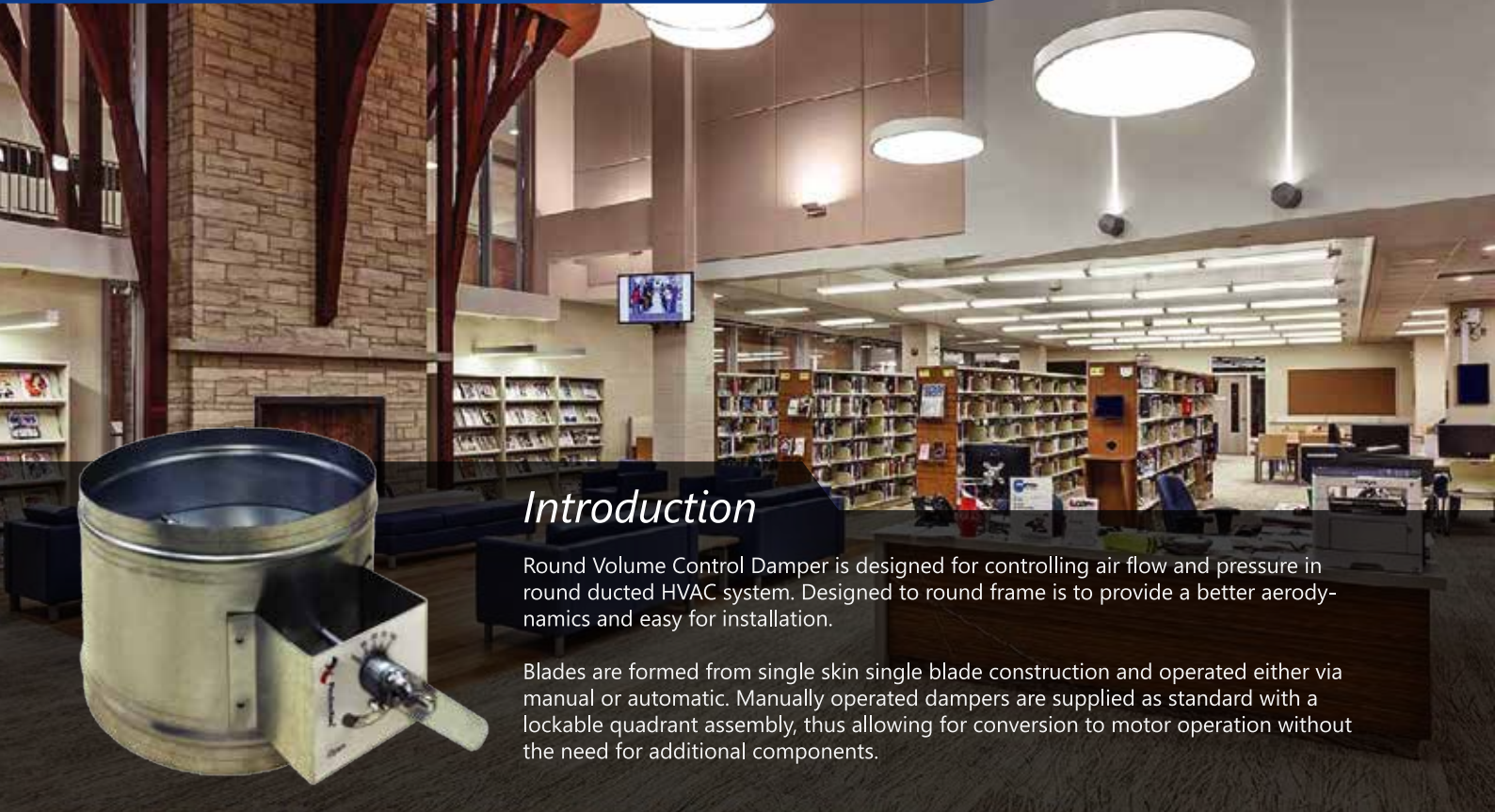

**RVCD** *Round Volume Control Damper*





## Introduction

Round Volume Control Damper is designed for controlling air flow and pressure in round ducted HVAC system. Designed to round frame is to provide a better aerodynamics and easy for installation.

Blades are formed from single skin single blade construction and operated either via manual or automatic. Manually operated dampers are supplied as standard with a lockable quadrant assembly, thus allowing for conversion to motor operation without the need for additional components.

## CONSTRUCTIONS & MATERIALS

- Single skin, single blade construction
- Available in manual or motorized models
- Actuation available in following configurations:
  - i) Hand locking quadrant arm
  - ii) Bare shaft
  - iii) Factory installed actuator

Frame Construction



Galvanized Steel  
(Size Dependant)

Blade Construction



Galvanized Steel  
(Size Dependant)

Construction Available



Stainless Steel  
Available

## DIMENSIONS

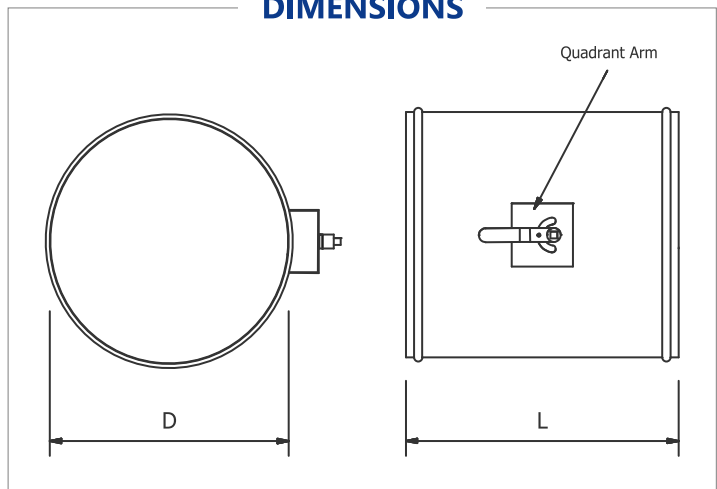

## STANDRAD SIZE AVAILABLE & DIMENSIONS

Size Ordering (Inch)	D mm	L mm
4	95	150
6	145	150
8	195	150
10	245	200
12	295	250
14	345	300
16	395	350

\*\* Other size and dimensions are available upon request. Maximum size can up to 1000mm diameter.



AERODYNAMIC PERFORMANCE

STATIC PRESSURE DROP

PRESSURE DROP VS DUCT VELOCITY

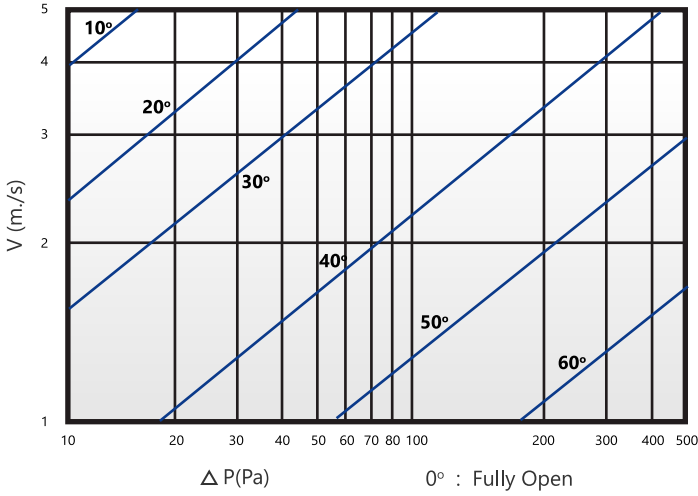

**V** Duct Velocity (m/s)  
**ΔP** Static Pressure Drop (Pa)  
 00, 100, 200, ... etc Degree Opening  
 Max static pressure drop for fully open dampers is 10 Pa

CLOSED DAMPER LEAKAGE

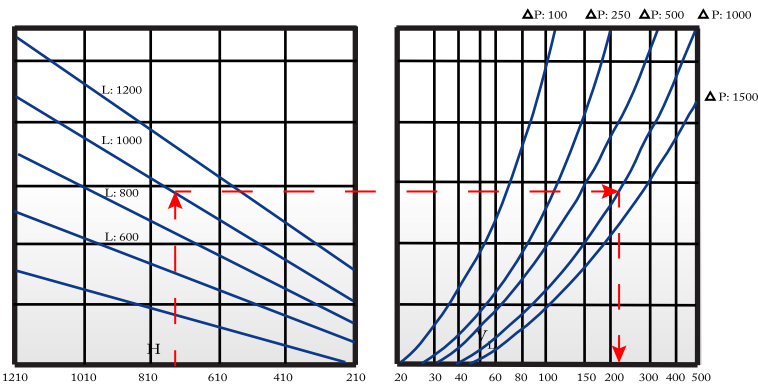

OPERATION RANGE

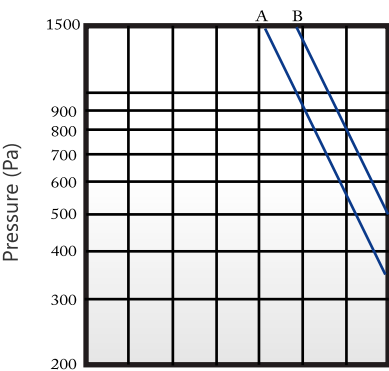

**L** Length (mm)      **VL** Volume Flowrate (cmh)      **A** Recommended operation range  
**H** Height (mm)      **ΔP** Pressure Difference (Pa)      **B** Critical operation range

ACTUATOR TORQUE REQUIREMENTS

FOR PRESSURE LESS OR EQUAL TO 500 PA

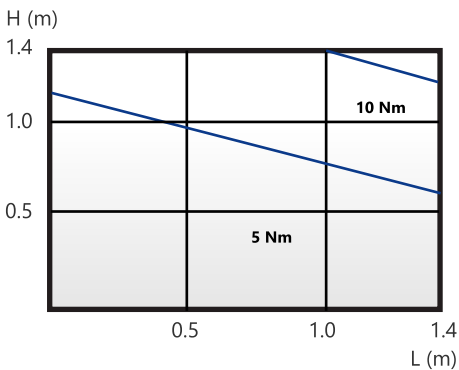

FOR PRESSURE LESS OR EQUAL TO 1000 PA

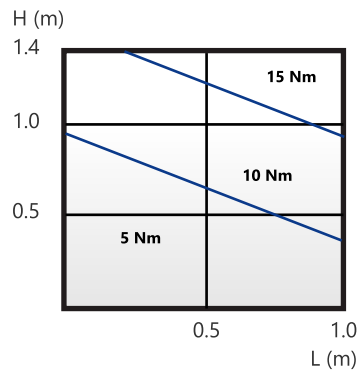

**H** Damper Height (m)  
**L** Damper Length (m)











# **RVCD** | *Round Volume Control Damper*



## Products Range

- Grilles 
- Diffusers 
- Dampers  ◀
- Fire & Smoke Protection 
- VAV 
- Others 
- Accessories 



**Prudent Aire Sdn Bhd** 514037-D  
 Lot 2102, Jalan KPB12, Off Jalan Suria Park 1, Kg Baru Balakong,  
 43300 Seri Kembangan, Selangor Darul Ehsan, Malaysia  
 Tel : +603-9100 3858 (HL) / 9101 3869 / 9101 5868  
 Fax : +603-9100 4868 Email : sales@prudentaire.com

[www.prudentaire.com](http://www.prudentaire.com)